

**IDLC1250 | 49.0L | 1,250 kW**

**INDUSTRIAL DIESEL GENERATOR SET**

EPA Certified Stationary Emergency

**GENERAC®** | **INDUSTRIAL POWER**

**Standby Power Rating**

1,250 kW, 1,563 kVA, 60 Hz

**Prime Power Rating\***

1,125 kW, 1,406 kVA, 60 Hz

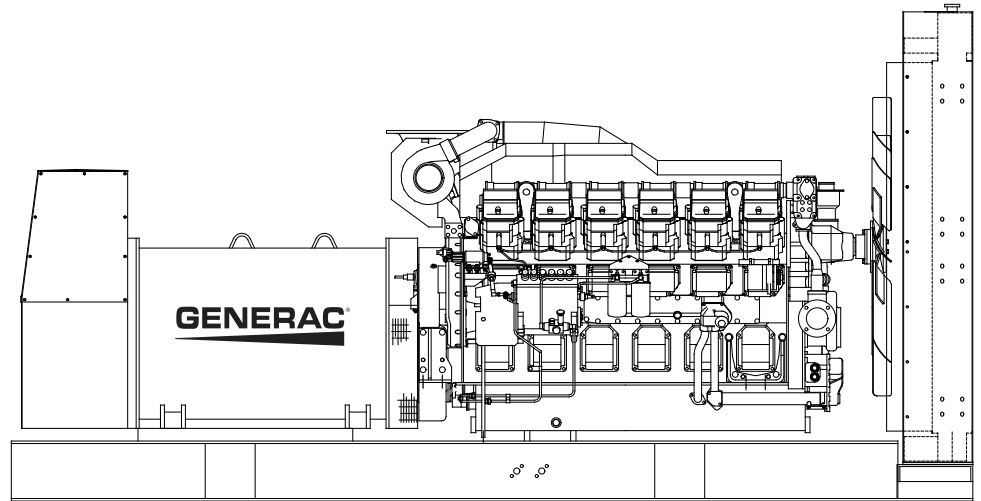

Image used for illustration purposes only



\*EPA Certified Prime ratings are not available in the US or its Territories

**Codes and Standards**

Not all codes and standards apply to all configurations. Contact factory for details.



UL2200, UL6200, UL1236, UL489, UL142



CSA C22.2



BS5514 and DIN 6271



SAE J1349



NFPA 37, 70, 99, 110



NEC700, 701, 702, 708



ISO 3046, 7637, 8528, 9001



NEMA ICS10, MG1, 250, ICS6, AB1



ANSI C62.41



IBC 2009, IBC 2012, ASCE 7-05, ASCE 7-10, ICC-ES AC-156 (2012)

**Powering Ahead**

For over 60 years, Generac has provided innovative design and superior manufacturing.

Generac ensures superior quality by designing and manufacturing most of its generator components, including alternators, enclosures and base tanks, control systems and communications software.

Generac gensets utilize a wide variety of options, configurations and arrangements, allowing us to meet the standby power needs of practically every application.

Generac searched globally to ensure the most reliable engines power our generators. We choose only engines that have already been proven in heavy-duty industrial applications under adverse conditions.

Generac is committed to ensuring our customers' service support continues after their generator purchase.

**STANDARD FEATURES**

**ENGINE SYSTEM**

- Oil Drain Extension
- Air Cleaner
- Fan Guard
- Stainless Steel Flexible Exhaust Connection
- Factory Filled Oil and Coolant
- Radiator Duct Adapter (Open Set Only)
- Engine Coolant Heater
- Critical Grade Silencer (Enclosed Units Only)

**Fuel System**

- Flexible Fuel Lines (When Tank is Selected)
- Primary Fuel Filter

**Cooling System**

- Closed Coolant Recovery System
- UV/Ozone Resistant Hoses
- Factory-Installed Radiator
- Radiator Drain Extension
- 50/50 Ethylene Glycol Antifreeze

**Electrical System**

- Battery Charging Alternator
- Battery Cables
- Battery Tray
- Rubber-Booted Engine Electrical Connections
- Solenoid Activated Starter Motor

**ALTERNATOR SYSTEM**

- Class H Insulation Material
- 2/3 Pitch
- Skewed Stator
- Permanent Magnet Excitation
- Sealed Bearing
- Full Load Capacity Alternator

**GENERATOR SET**

- Separation of Circuits - High/Low Voltage
- Separation of Circuits - Dual Breakers
- Standard Factory Testing
- 2 Year Limited Warranty (Standby Rated Units)
- 1 Year Limited Warranty (Prime Rated Units)

**ENCLOSURE (If Selected)**

- Structural Steel Sub-Base
- Sub-Base Lifting Eyes
- Enamel Finish
- Zinc Plated Fasteners
- Zinc Plated Cast Aluminum Keylock Door Handles
- Heavy Duty Stainless Steel Hinges with Removable Brass Pins
- Modular Construction

**FUEL TANKS (If Selected)**

- UL 142
- Double Wall
- Vents
- Factory Pressure Tested (2 psi)
- Rupture Basin Alarm
- Fuel Level
- Check Valve in Supply and Return Lines
- Stainless Steel Hardware
- Fuel Line Hose
- Fuel Line Hose and Separator
- Electronic Fuel Level
- Secondary Fuel Filter

**CONTROL SYSTEM**

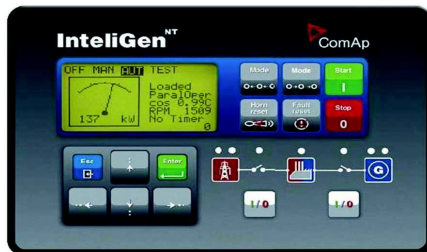

**IntelliGen NT Display**

**Program Functions**

- Programmable Crank Limiter
- 7-Day Programmable Exerciser
- Special Applications Programmable Logic Controller
- RS-232/485 Communications
- 2-Wire Start Capability
- Date/Time Fault History (Event Log)
- Isochronous Governor Control
- Waterproof/Sealed Connectors
- Audible Alarms and Shutdowns
- Not in Auto (Flashing Light)
- Auto/Off/Manual Switch

- Customizable Alarms, Warnings, and Events
- Modbus® Protocol
- Predictive Maintenance Algorithm
- Sealed Boards
- Password Parameter Adjustment Protection
- Single Point Ground
- 16 Channel Remote Trending
- 0.2 msec High Speed Remote Trending
- Alarm Information Automatically Annunciated on the Display

**Full System Status Display**

- Power Output (kW)
- Power Factor
- kW Hours, Total, and Last Run
- Real/Reactive/Apparent Power
- All Phase AC Voltage
- All Phase Currents
- Oil Pressure
- Coolant Temperature
- Coolant Level
- Engine Speed
- Battery Voltage
- Frequency

**Alarms and Warnings**

- Oil Pressure
- Coolant Temperature
- Coolant Level
- Engine Overspeed
- Battery Voltage
- Alarms and Warnings Time and Date Stamped
- Snap Shots of Key Operation Parameters During Alarms and Warnings
- Alarms and Warnings Spelled Out (No Alarm Codes)

**CONFIGURABLE OPTIONS**

**ENGINE SYSTEM**

- 50° Ambient Cooling System
- Critical and Hospital Grade Silencers
- Critical Grade Exhaust (Open Set Only)
- CCV (Closed Crankcase Ventilation)
- Engine Drain Kit
- Air Cleaner with Indicator

**ELECTRICAL SYSTEM**

- 10A UL Battery Charger
- 20A UL Battery Charger
- Battery Warmer

**ALTERNATOR SYSTEM**

- Alternator Upsizing
- Anti-Condensation Heater

**CIRCUIT BREAKER OPTIONS**

- Main Line Circuit Breaker
- 2nd Main Line Circuit Breaker
- Shunt Trip and Auxiliary Contact
- Electronic Trip Breakers

**GENERATOR SET**

- Spring Isolators (Standard/Seismic)

**ENCLOSURE**

- Weather Protected Enclosure
- Level 1 Sound Attenuated with Motorized Dampers
- Level 2 Sound Attenuated with Motorized Dampers
- Steel Enclosure
- Aluminum Enclosure
- Up to 200 MPH Wind Load Rating (Contact Factory for Availability)
- Louvers with Gravity Dampers
- Enclosure Heaters (Motorized Dampers Only)
- AC Electrical Lighting Package (ELP) Enclosure Heater

**WARRANTY (Standby Gensets Only)**

- 2 Year Extended Limited Warranty
- 5 Year Limited Warranty
- 5 Year Extended Limited Warranty
- 7 Year Extended Limited Warranty
- 10 Year Extended Limited Warranty

**CONTROL SYSTEM**

- NFPA110 Level I and II (Programmable) 15- LED Remote Annunciator
- Remote Relay Assembly (8 or 16)
- Shipped Loose Remote E-Stop - Surface Mount
- Generator Control Panel Mounted E-Stop
- Remote Communication - InternetBridge NT
- 10A Engine Run Relay
- Low Coolant Level Indication
- 90% High Fuel Alarm

**FUEL TANKS (Size on Last Page)**

- Mechanical Fuel Level
- 12 Hour Run Time
- 24 Hour Run Time

**ENGINEERED OPTIONS**

**ENGINE SYSTEM**

- Coolant Heater Ball Valves
- Oil Heater
- Fuel Cooler
- High Lift Pumps
- Heavy Duty Air Filters (Open Set Only)

**ALTERNATOR SYSTEM**

- 3rd Breaker System
- 4th Breaker Options
- Unit Mounted Load Banks
- Medium Voltage Alternators
- Digital Voltage Regulator

**CONTROL SYSTEM**

- Spare Inputs (x4) / Outputs (x4)
- Battery Disconnect Switch
- PM-SCi

**GENERATOR SET**

- Special Testing
- 12 VDC Enclosure Lighting Kit
- 24 VDC/120 VAC Enclosure Lighting Kit

**ENCLOSURE**

- Door Open Alarm Switch
- Level 3 Sound Attenuated Enclosure
- Custom Enclosure

**TANKS**

- Overfill Protection Valve
- UL2085 Tank
- ULC S601 Tank
- Special Fuel Tanks
- External Vent Extensions
- Transfer Pumps and Controllers
- Fuel Tank Heaters

# IDLC1250 | 49.0L | 1,250 kW

## INDUSTRIAL DIESEL GENERATOR SET

EPA Certified Stationary Emergency

### APPLICATION AND ENGINEERING DATA

#### ENGINE SPECIFICATIONS

##### General

Make	Mitsubishi
Model	S12R-Y2PTAW-1
EPA Emissions Compliance	Tier 2
EPA Emissions Reference	See Emission Data Sheet
Cylinder #	12
Type	4 Cycle - V12
Displacement - in <sup>3</sup> (L)	2,992 (49.0)
Bore - in (mm)	6.69 (170)
Stroke - in (mm)	7.09 (180)
Compression Ratio	14.5:1
Intake Air Method	Turbocharged/Intercooled
Cylinder Head	4-Valve
Piston Type	Aluminum
Crankshaft Type	Dropped Forged Steel

##### Engine Governing

Governor	Electronic
Frequency Regulation (Steady State)	±0.25%

##### Lubrication System

Oil Pump Type	Gear
Oil Filter Type	Cartridge
Crankcase Capacity - qt (L)	158.5 (150)

##### Cooling System

Cooling System Type	Unit Mounted Radiator
Water Pump Type	Centrifugal
Fan Type	Pusher
Fan Speed - RPM	710
Fan Diameter - in (mm)	88 (2,235)

##### Fuel System

Fuel Type	Ultra Low Sulfur Diesel #2
Fuel Specifications	ASTM
Fuel Filtering (Microns)	10 (Final Filters)
Fuel Inject Pump Make	Mechanical
Fuel Pump Type	Engine Driven Gear
Injector Type	Mitsubishi PS8 Type x 2
Fuel Supply Line - in (mm)	0.75" NPT (19.0)
Fuel Return Line - in (mm)	0.75" NPT (19.0)

##### Engine Electrical System

System Voltage	24 VDC
Battery Charger Alternator	Standard
Battery Size	See Battery Index 0161970SBY
Battery Voltage	(4) - 12 VDC
Ground Polarity	Negative

#### ALTERNATOR SPECIFICATIONS

Standard Model	K2112064N22
Poles	4
Field Type	Rotating
Insulation Class - Rotor	H
Insulation Class - Stator	H
Total Harmonic Distortion	<5%
Telephone Interference Factor (TIF)	< 50

Standard Excitation	Permanent Magnet
Bearings	Single Sealed Cartridge
Coupling	Direct via Flexible Disc
Load Capacity- Standby	100%
Prototype Short Circuit Test	Yes
Voltage Regulator Type	Analog
Regulation Accuracy (Steady State)	±0.5%

# IDLC1250 | 49.0L | 1,250 kW

## INDUSTRIAL DIESEL GENERATOR SET

EPA Certified Stationary Emergency

### OPERATING DATA

#### POWER RATINGS

		Standby
Three-Phase 277/480 VAC @0.8pf	1,250 kW	Amps: 1,882
Three-Phase 346/600 VAC @0.8pf	1,250 kW	Amps: 1,505

#### MOTOR STARTING CAPABILITIES (skVA)

skVA vs. Voltage Dip	
277/480 VAC	30%
K2112064N22	7,709
K2268064N22	9,417

#### FUEL CONSUMPTION RATES\*

Fuel Pump Lift- ft (m)	Diesel - gph (Lph)	
	Percent Load	Standby
3 (1)	25%	32.2 (122.0)
	50%	56.4 (213.0)
	75%	82.9 (314.0)
	100%	114.0 (432.0)
Total Fuel Pump Flow (Combustion + Return) - gph (Lph)		
127 (479)		

\* Fuel supply installation must accommodate fuel consumption rates at 100% load.

#### COOLING

Cooling Rating - Jacket Water			Cooling Rating - Aftercooler		
		Standby			Standby
Coolant Flow	gpm (Lpm)	489 (1,851)	Coolant Flow	gpm (Lpm)	90 (341)
Coolant System Capacity	gal (L)	95 (360)	Coolant System Capacity	gal (L)	50 (189)
Heat Rejection to Coolant	BTU/hr (kW)	1,829,820 (536)			
Inlet Air- 40°C Cooling Package	scfm (m³/min)	66,100 (1,872)			
Inlet Air- 50°C Cooling Package	scfm (m³/min)	70,800 (2,005)			
Max. Operating Ambient Temp	°F (°C)	104 (40)			
Max Operating Ambient Temperature (Before Derate)	see Bulletin No. 0199270SSD				
Maximum Additional Radiator Backpressure	in H <sub>2</sub> O (kPa)	0.5 (0.12)			

#### COMBUSTION AIR REQUIREMENTS

	Standby
Flow at Rated Power - scfm (m³/min)	4,767 (135)

#### ENGINE

		Standby
Rated Engine Speed	RPM	1,800
Horsepower at Rated kW**	hp	1,881
Piston Speed	ft/min (m/min)	2,126 (648)
BMEP	psi (kPa)	276 (1,903)

#### EXHAUST

		Standby
Exhaust Flow (Rated Output)	scfm (m³/min)	12,570 (356)
Max. Allowable Backpressure (Post Turbo)	inHg (kPa)	1.7 (5.87)
Exhaust Temp (Rated Output - Post Silencer)	°F (°C)	932 (500)

\*\* Refer to "Emissions Data Sheet" for maximum bHP for EPA and SCAQMD permitting purposes.

Deration – Operational characteristics consider maximum ambient conditions. Derate factors may apply under atypical site conditions.

Please contact a Generac Power Systems Industrial Dealer for additional details. All performance ratings in accordance with ISO3046, BS5514, ISO8528, and DIN6271 standards.

Standby - See Bulletin 10000018933

Prime - See Bulletin 10000018926

**DIMENSIONS AND WEIGHTS\***

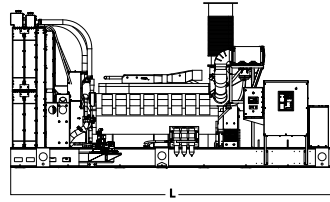
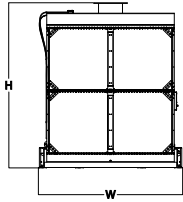

**OPEN SET (Includes Exhaust Flex)**

Run Time - Hours	Usable Capacity - Gal (L)	L x W x H - in (mm)	Weight - lbs (kg) (Enclosure Only)	
No Tank	-	215.7 (5,478) x 93.0 (2,362) x 115.1 (2,924)	26,045 (11,814)	
12	1,250 (4,732)	243.0 (6,172) x 116.0 (2,945) x 132.1 (3,356)	Contact Factory	
24	2,500 (9,464)	243.0 (6,172) x 116.0 (2,945) x 148.0 (3,759)	Contact Factory	

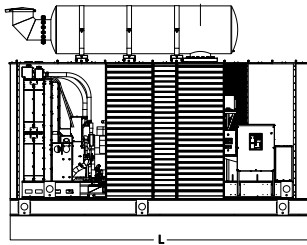
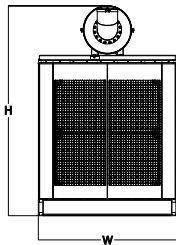

**WEATHER PROTECTED ENCLOSURE**

Run Time - Hours	Usable Capacity - Gal (L)	L x W x H - in (mm)	Weight - lbs (kg) (Enclosure Only)	
			Steel	Aluminum
No Tank	-	244.0 (6,198) x 110.0 (2,791) x 184.0 (4,661)	Contact Factory	
12	1,250 (4,732)	264.0 (6,698) x 110.0 (2,791) x 201.0 (5,093)	Contact Factory	Contact Factory
24	2,500 (9,464)	264.0 (6,698) x 110.0 (2,791) x 217.0 (5,499)	Contact Factory	Contact Factory

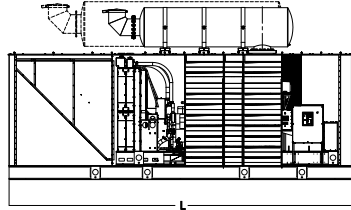
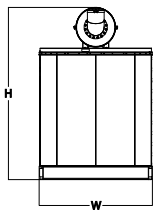

**LEVEL 1 SOUND ATTENUATED ENCLOSURE**

Run Time - Hours	Usable Capacity - Gal (L)	L x W x H - in (mm)	Weight - lbs (kg) (Enclosure Only)	
			Steel	Aluminum
No Tank	-	327.0 (8,306) x 119.0 (3,021) x 184.0 (4,674)	Contact Factory	
12	1,250 (4,732)	330.0 (8,382) x 119.0 (3,021) x 206.3 (5,239)	Contact Factory	Contact Factory
24	2,500 (9,464)	330.0 (8,382) x 119.0 (3,021) x 208.0 (5,284)	Contact Factory	Contact Factory

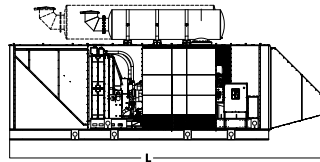
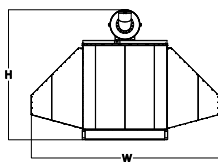

**LEVEL 2 SOUND ATTENUATED ENCLOSURE**

Run Time - Hours	Usable Capacity - Gal (L)	L x W x H - in (mm)	Weight - lbs (kg) (Enclosure Only)	
			Steel	Aluminum
No Tank	-	404.0 (10,268) x 262.0 (6,666) x 126.0 (3,209)	Contact Factory	
12	1,250 (4,732)	404.0 (10,268) x 262.0 (6,666) x 140.0 (3,565)	Contact Factory	Contact Factory
24	2,500 (9,464)	404.0 (10,268) x 262.0 (6,666) x 150.0 (3,819)	Contact Factory	Contact Factory

\* All measurements and weights are approximate and for estimation purposes only.

**YOUR FACTORY RECOGNIZED GENERAC INDUSTRIAL DEALER**

Specification characteristics may change without notice. Please contact a Generac Power Systems Industrial Dealer for detailed installation drawings.